

MODEL # L-007

- Construction: All brass components, 3/8" schedule 40 brass stem, copper shade (18 ga).
- Stem Height: 12" height is standard. 8", 16" and 20" stem heights are available options.
- Lens: Borosilicate frosted glass is standard.
- Mounting: 1/2" male thread. Mounts into standard J-box or:
GS-1 Standard ground spike.
GS-2 Heavy duty ground spike.
- Finish: Unfinished. Fixture will weather to a natural patina finish.
- Voltage: 12 volts.
- Lamp:

#S8-18W (standard)	18 watt S-8 incandescent
#S8-13W	13 watt S-8 incandescent
#S8-26W	26 watt S-8 incandescent
#10W-X	10 watt G-4 bi-pin xenon
#15W-X	15 watt G-4 bi-pin xenon
#20W-X	20 watt G-4 bi-pin xenon
#10W-H	10 watt G-4 bi-pin halogen
#20W-H	20 watt G6.35 bi-pin halogen
#35W-H	35 watt G6.35 bi-pin halogen

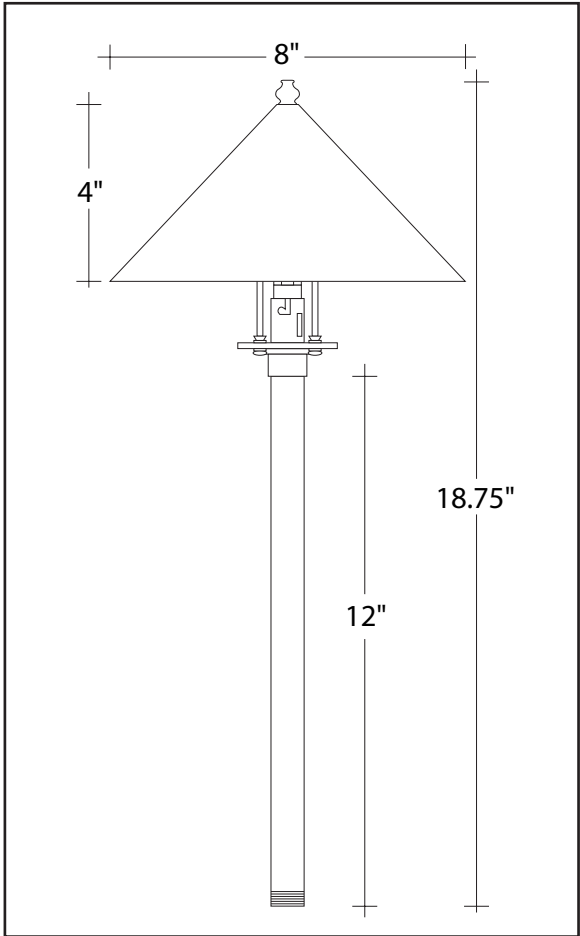

Horizontal footcandles at radius from fixture with standard 12" stem height

Lamp:	1'	2'	3'	4'	5'	6'
#S8-18W	6.2	2.0	1.4	1.0	.7	.5
#S8-13W	5.1	1.9	1.2	.8	.6	.4
#S8-26W	7.9	3.3	2.0	1.4	1.2	.9
#10W-X	3.5	1.7	1.3	1.0	.8	.6
#15W-X	4.5	1.9	1.5	1.3	1.0	.8
#20W-X	6.7	2.3	1.8	1.4	1.2	1.0
#20W-H	10.2	3.4	2.0	1.5	1.3	1.1
#35W-H	21.7	6.3	3.4	2.0	1.7	1.6

Ordering Example

L-007 — 12 — S8-18W — GS-1
 Fixture Model Stem Height Lamp Type Mounting Accessory (if any)

