

MODEL # L-013-R8

- Construction: Copper shade, all brass components, 1/8" thick brass housing.
- Lens Top: Tempered, round borosilicate (frosted).
- Lens bottom: Tempered, flat soda lime (clear).
- Mounting: Fixture plate mounts onto recessed standard 4" round bell-type J-box with hole spacing at 3 1/2" on center (by others).
- Finish: Unfinished. Fixture will weather to a natural patina finish.
- Voltage: 12 volts. Remote transformer required. See Electronic Transformer specification sheet.
- Accessory: HL-1 Honeycomb louver.
- Top Lamp: #20W-H 20 watt G6.35 bi-pin halogen
#35W-H 35 watt G6.35 bi-pin halogen (max.)
- Bottom Lamp: MR-16 bi-pin halogen, 35 watt maximum. Lamp is recessed in fixture to reduce glare.

JR-10	10 watt medium	(24 degrees)
ESX	20 watt spot	(12 degrees)
BBF	20 watt medium	(24 degrees)
BAB	20 watt flood	(36 degrees)
FMT	35 watt spot	(12 degrees)
FMV	35 watt medium	(24 degrees)
FMW	35 watt flood	(36 degrees)

See separate MR-16 lamp sheet for data.

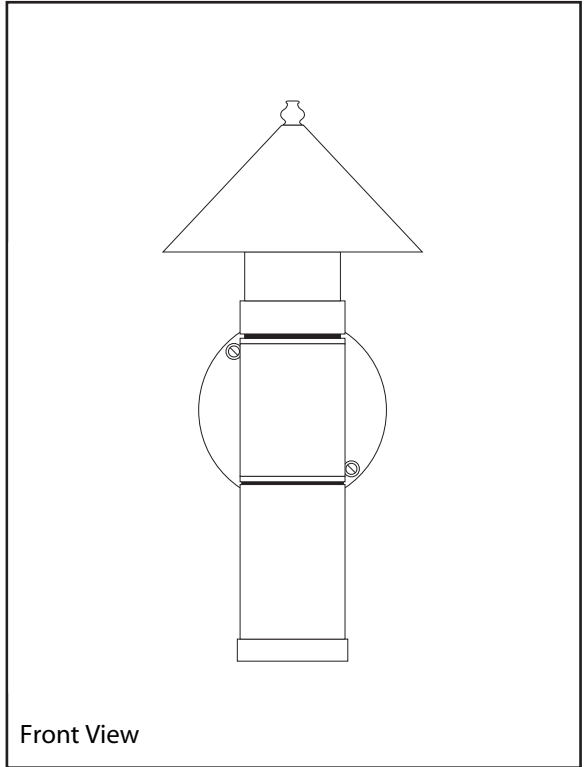
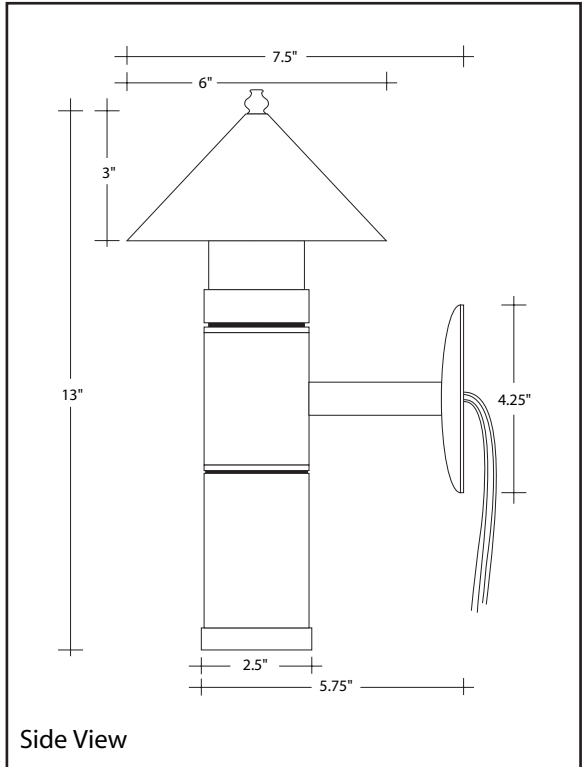

Ordering Example

L-013-R8 — 20W-H — BAB — HL-1
 Fixture Model Lamp Type (Top) Lamp Type (Bottom) Accessory

